

Company	000 "Ferro"
Item No:	E65/32/27(EE65)

Table of Mn-Zn MATERIALS CHARACTERISTICS

	Unit	Measuring Conditions		PC40
Initial permeability μ_i	—	1kHz	23±3°C	2300±25%
Core loss P_v	mW/cm^3	100kHz 200mT	25°C	600
			60°C	450
			100°C	410
			120°C	480
Saturation magnetic flux B_s	mT	1194A/m	25°C	510
			60°C	450
			100°C	390
			120°C	350
Retentivity	mT		25°C	95
			60°C	65
			100°C	55
			120°C	50
Coercivity	A/m		25°C	14.3
			60°C	10.3
			100°C	8.8
			120°C	8
Cuire Temperature T_c	°C			>215
Resistivity P	$\Omega \cdot m$			6.5
Apparent density d	g/cm^3			4.8

1mt=10guass, 1A/m=0.012566Oersted

CURVES OF Mn-Zn MATERIALS CHARACTERISTICS

PC40

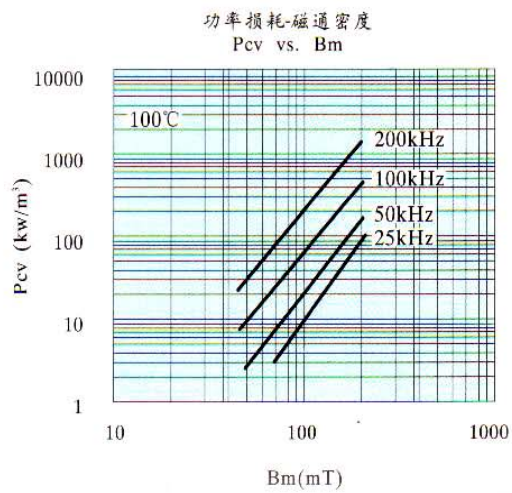
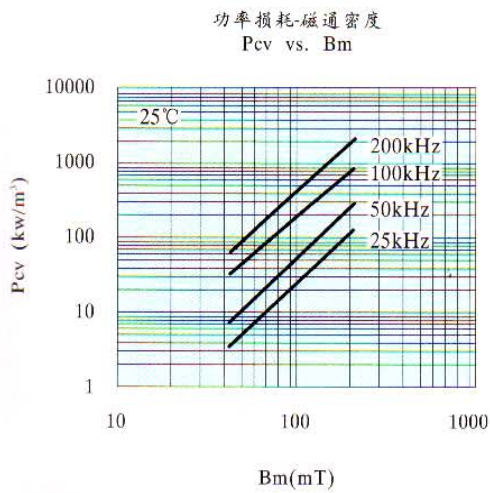
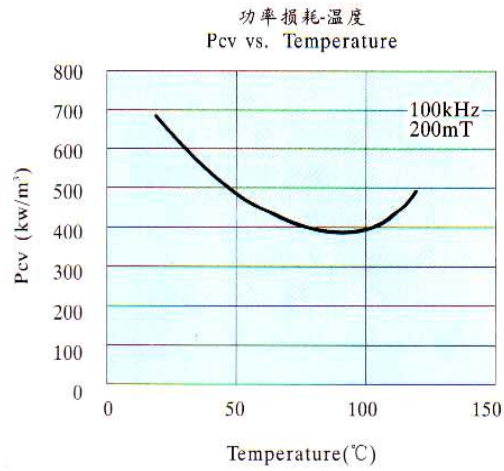
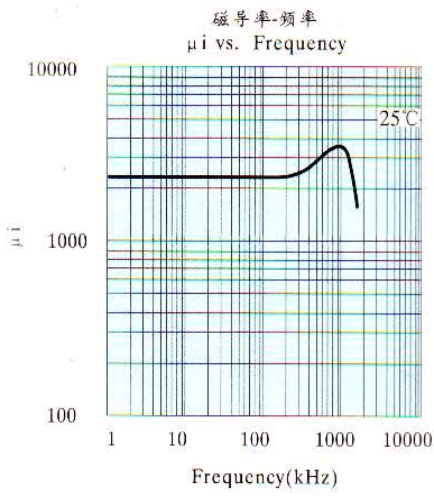
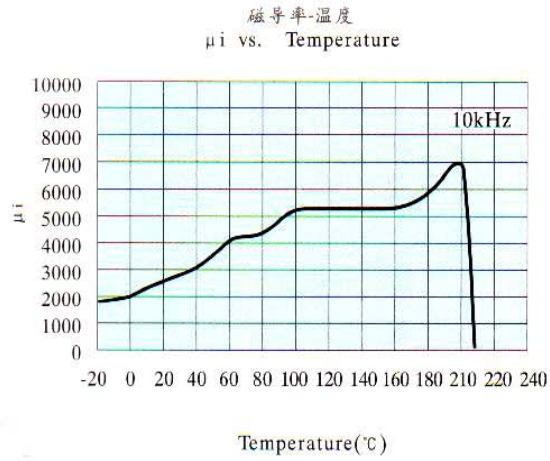
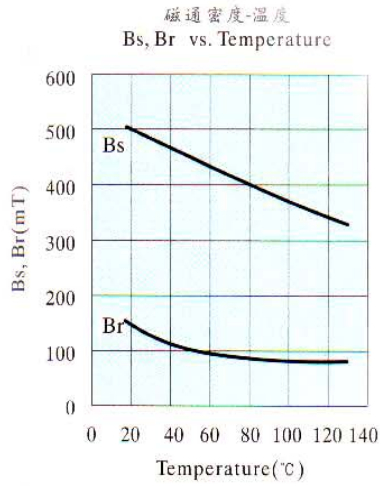

SPECIFICATION

1. MATERIAL: PC40

2. DIMENSION (mm)

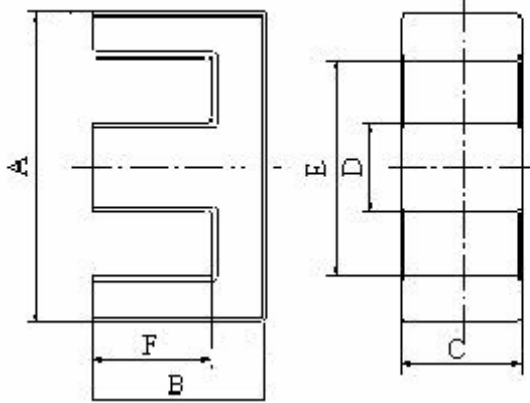

A	65.4±1.3
B	32.5±0.3
C	27.4±1.0
D	19.65±0.35
E	44.2 min
F	22.55±0.35

3. CORE SET PARAMETER

Effective core length	Le	147.13	mm
Effective cross section	Ae	530.94	mm ²
Effective volume	Ve	78116.1	mm ³
weight	Wg	410	g/set

4. ELECTRICAL CHARACTERISTICS

4.1 INDUCTANCE

AL-VALUE 7600(nH/N*N)±25%

Test Conditions 1KHz 0.3V \varnothing 0.35*100Ts 23±3°C

4.2 POWER LOSS: PL≤50W max

4.3 Test Condition: 100kHz 200mT 10Ts 80~100°C

	Item No	E65/32/27(EE65)		
	Name	Ferrite Core		
	Revision	A1	Page No	4/5

4.3 TEST INSTRUMENTATION

For INSUCTANCE: TH2816B

For POWER consumption: GHY/5 tester

5. Maximum chip off

5.1 The depth of crack in the ground surface should be no more than 1/4,length is no more than 1/4,length of lengthen line in the non-ground surface, the depth should be no more than 1/3,length is no more than 1/3 length of lengthen line.

5.2 The total chip square should be no more than 3.0 mm², quantity should be no more than 3.In the non-ground surface,the total chip square should be no more than 6.0 mm², and quantity should be no more than 4

6. Inspection Method

According to GB2828.1-2003,one time normal random sampling,Inspect level II ,

AQL should be as follows:

	AQL	Inspect Item
A	0.65	Electromagnetic Property
B	1.0	Outside Size
C	1.5	Outside Quality

7. Packing

Formed plastic box is used to inside packing, paper box is used to outside packing, each package's right or left side shows product model and ROHS certificate

	Item No	E65/32/27(EE65)		
	Name	Ferrite Core		
	Revision	A1	Page No	5/5