

Company	000 "Ferro"
Item No:	E42/21/15(EE42/15)

Table of Mn-Zn MATERIALS CHARACTERISTICS

	Unit	Measuring Conditions		PC40
Initial permeability $\mu_i$	—	1kHz	23±3°C	2300±25%
Core loss $P_v$	$mW/cm^3$	100kHz 200mT	25°C	600
			60°C	450
			100°C	410
			120°C	480
Saturation magnetic flux $B_s$	mT	1194A/m	25°C	510
			60°C	450
			100°C	390
			120°C	350
Retentivity	mT		25°C	95
			60°C	65
			100°C	55
			120°C	50
Coercivity	A/m		25°C	14.3
			60°C	10.3
			100°C	8.8
			120°C	8
Cuire Temperature $T_c$	°C			>215
Resistivity P	$\Omega \cdot m$			6.5
Apparent density d	$g/cm^3$			4.8

1mt=10guass, 1A/m=0.012566Oersted

CURVES OF Mn-Zn MATERIALS CHARACTERISTICS

PC40

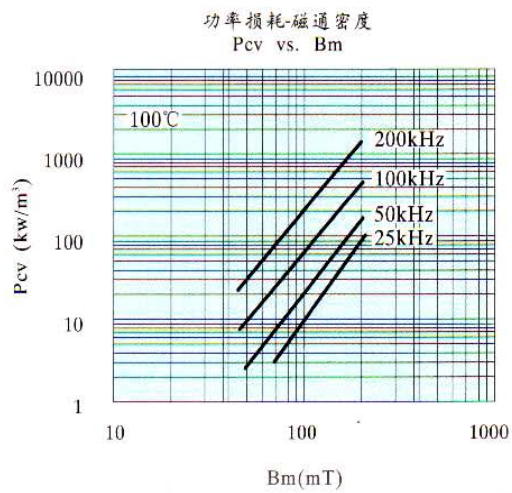
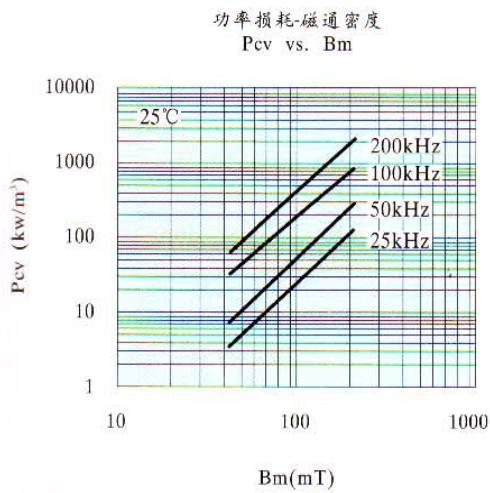
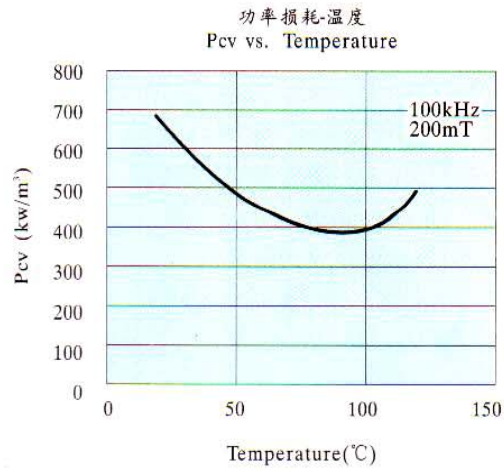
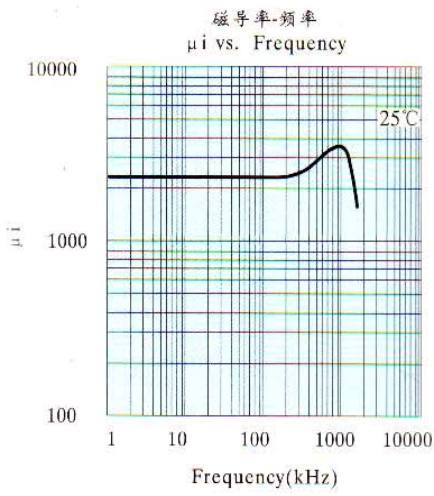
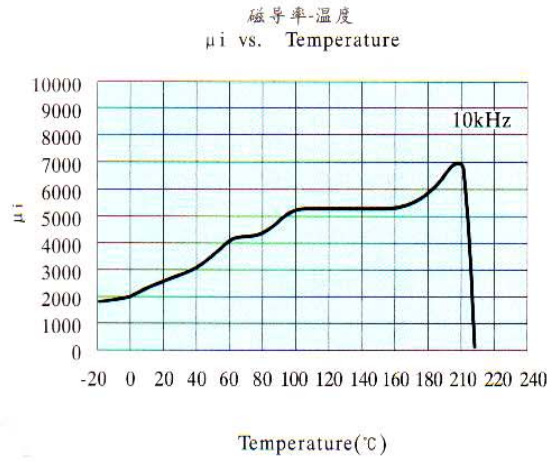
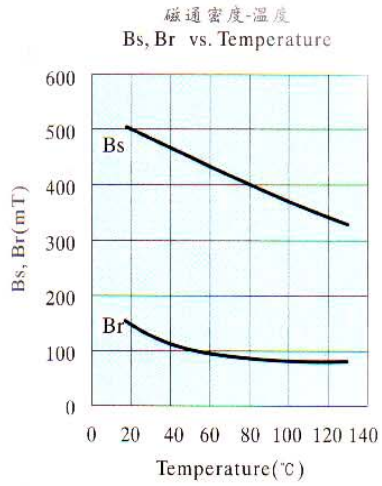

# SPECIFICATION

1. MATERIAL: PC40

2. DIMENSION (mm)

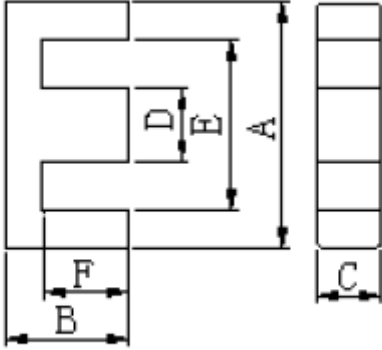

A	42.0+1.0/-0.7
B	15.2 ± 0.4
C	20.0 + 0.2/-0.4
D	20.0 + 0.2/-0.4
E	29.5min
F	15.4 ± 0.3

3. CORE SET PARAMETER

Core constant	$C_1$	0.44	$\text{mm}^{-1}$
Effective core length	$L_e$	98.19	mm
Effective cross section	$A_e$	224.91	$\text{mm}^2$
Effective volume	$V_e$	22084	$\text{mm}^3$
weight	$W_g$	88g/set	

4. ELECTRICAL CHARACTERISTICS

4.1 INSUCTANCE

AL-VALUE 4500 (nH/N\*N)±25%

Test Conditions 1KHz 0.3V  $\varnothing$  0.35\*100Ts 25±2°C

4.2 POWER LOSS:  $P \leq 135\text{mw/g}$  3Ts 100kHz, 200m T100 ± 3

4.3 Test Condition: 1kHz 200mT 3Ts (0.35mm) U=91.94V

	Item No	E42/21/15(E42/15)		
	Name	Ferrite Core		
	Revision	A1	Page No	4/5

### 4.3 TEST INSTRUMENTATION

For INSUCTANCE: YD2817

For POWER consumption: WL3866B

## 5. Maximum chip off

5.1 The depth of crack in the ground surface should be no more than 1/4,length is no more than 1/4,length of lengthen line in the non-ground surface, the depth should be no more than 1/3,length is no more than 1/3 length of lengthen line.

5.2 The total chip square should be no more than 3.0 mm<sup>2</sup>, quantity should be no more than 3.In the non-ground surface,the total chip square should be no more than 6.0 mm<sup>2</sup>, and quantity should be no more than 4

## 6. Inspection Method

According to GB2828.1-2003,one time normal random sampling,Inspect level II ,

AQL should be as follows:

	AQL	Inspect Item
A	0.65	Electromagnetic Property
B	1.0	Outside Size
C	1.5	Outside Quality

## 7. Packing

Formed plastic box is used to inside packing, paper box is used to outside packing, each package's right or left side shows product model and ROHS certificate

	Item No	E42/21/15(EE42/15)		
	Name	Ferrite Core		
	Revision	A1	Page No	5/5